



Translucent Building Elements

Lichtbauelemente



TRANSLUCENT BUILDING ELEMENTS

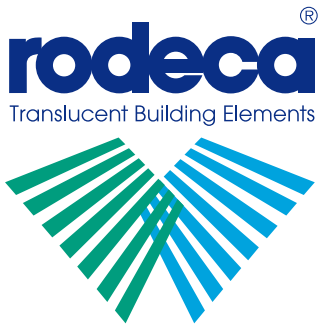

Translucent Building Elements



Multi Wall Sheets
Hohkammerscheiben



Multi Function Panels
Multi - Funktions-Paneele



U-Panels
U-Paneele



Translucent Building Elements

Available thicknesses/ manufacturing program

30	Panel	Up-value W/m ² K**	Weight in kg/m ²	Building width (mm)
	2530-4	1.4 - 1.7 W/m ² K	approx. 3.4 kg/m ²	500 (+1/-1%)

PC 2530-4

Colours
Standard: crystal / opal



Color version: from 300 m²

Advantages

- Polycarbonate is a crystal clear, high impact thermoplastic
- Temperature resistance from -40 to +115°C, temporarily up to 130°C
- Impact resistance virtually unchanged within these temperatures
- Good long term performance through UV protection
- 10 years warranty against yellowing - ageing - hail stone
- Translucent with excellent thermal properties

40	Panel	Up-value W/m ² K**	Weight in kg/m ²	Building width (mm)
	2540-4	1.3 - 1.5 W/m ² K	approx. 4.0 kg/m ²	500 (+1/-1%)
	2540-4 MC	1.3 - 1.6 W/m ² K	approx. 4.0 kg/m ²	500 (+1/-1%)
	2540-6	1.1 - 1.2 W/m ² K	approx. 4.2 kg/m ²	500 (+1/-1%)
	2540-7	1.0 - 1.1 W/m ² K	approx. 4.3 kg/m ²	500 (+1/-1%)
	2540-10	0.99 - 1.0 W/m ² K	approx. 4.2 kg/m ²	500 (+1/-1%)

PC 2540-4

Colours:
Standard: crystal / opal / Bicolor*
*Upon request both sides UV-coextrusion possible



Color version: from 300 m²
Bicolor version: from 150 m²

Applications

- Glazings
- Sports and industrial halls
- Roofing construction
- Northern Lights
- Window glazing
- Interior applications, e. g. partition walls or exhibition stand constructions
- Refurbishments for wall and roof
- Rain screens
- Curtain facades

PC 2540-4 MC

Colours:
Standard: crystal / opal



Color version: from 300 m²

PC 2540-6

Colours:
Standard: crystal / opal / color*



Color version: from 300 m²

PC 2540-7

Colours:
Standard: crystal / opal/ Decocolor*
*Upon request both sides UV-coextrusion possible

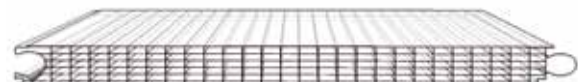

Color version: from 450 m²
Decocolor version: from 150 m²

PC 2540-10

Colours:
Standard: crystal / opal

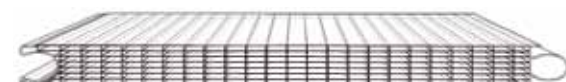

Color version: from 300 m²





 RT-Thermolight
RT-Thermolight

 RT-Roof Lights
RT-Dachlichtbänder

 Windows
Fenster

 Do it yourself
Do it yourself

50	Panel	Up-value W/m ² K**	Weight per kg/m ²	Building width (mm)
	2550-10	0.80 - 0.89 W/m ² K	approx. 5.0 kg/m ²	495 (+1/-1%)

PC 2550-10

Colours:
Standard: crystal / opal / color*

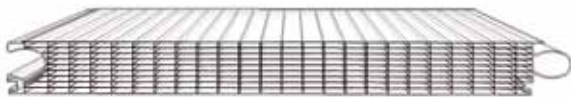

Duocolor version: from 300 m²
Color version: from 300 m²

60	Panel	Up-value W/m ² K**	Weight per kg/m ²	Building width (mm)
	2560-12	0.71 - 0.77 W/m ² K	approx. 5.8 kg/m ²	500 (+1/-1%)

PC 2560-12

Colours:
Standard: crystal / opal

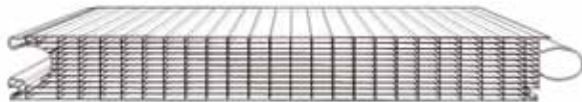

Color version: from 300 m²

Product versions

Color version: fully coloured panel



Bicolor version: colouring of the inner layer



Decocolor version: colouring of the outer layer



Duocolor version: colouring of approx. one half of the panel



* Minimum quantities, other colour combinations and our versatile product versions can be viewed in our technical manuals.

** Up-values

Depending on horizontal or vertical installation situation as interior or exterior application according to DIN EN ISO 6946:2008/ DIN EN ISO 10077-2:2008

Panels

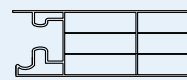

30

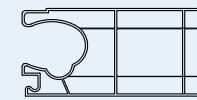

40

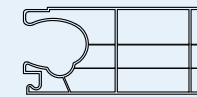

50

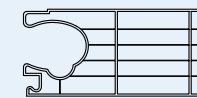

60

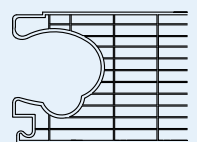
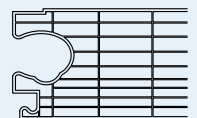
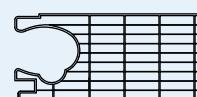
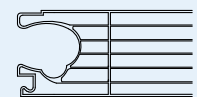

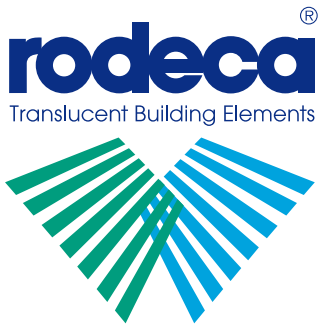

Translucent Building Elements

Multi Wall Sheets
Hohkammerscheiben

Multi Function Panels
Multi - Funktions-Paneele

U-Panels
U-Paneele

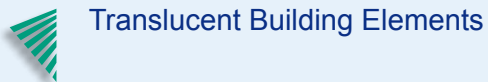

Fastening / fixing

The fasteners slide into the panel groove and are fixed at the substructure. The fasteners provide a continuous and seamless glazing, which gives a light and smooth appearance to the façade.

Fastener

The Rodeca clip fastener is made of extruded aluminium (EN AW 6060, status T66 according to DIN EN 755-2).

40	System	Clip fastener
	PC 2540-x AF 50	49404050
	PC 2540-x AF 100	494040100

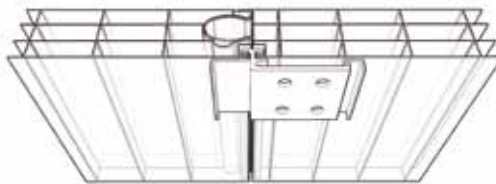
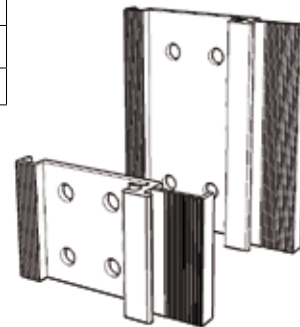

Types

- Clip fastener
- Aluminium continuous fastener
- Translucent PC continuous fastener

Continuous fastener

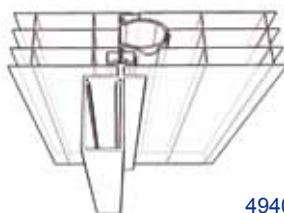

494096

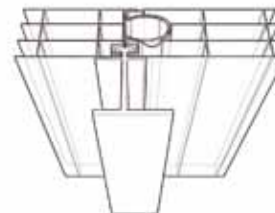

494097

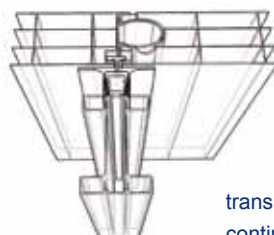

translucent polycarbonate
continuous fastener
304001+304002





 RT-Thermolight
RT-Thermolight

 RT-Roof Lights
RT-Dachlichtbänder

 Windows
Fenster

 Do it yourself
Do it yourself

30

System	Clip fastener
PC 2530-4 AF 50	49404050
PC 2530-4 AF 100	494040100

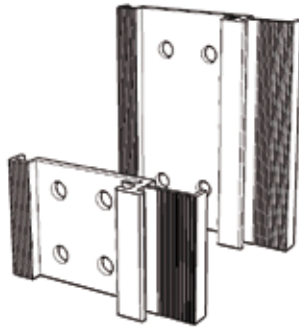
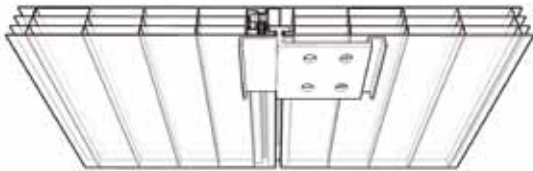

50

System	Clip fastener
PC 2550-10 AF 60	49405060
PC 2550-10 AF 120	494050120

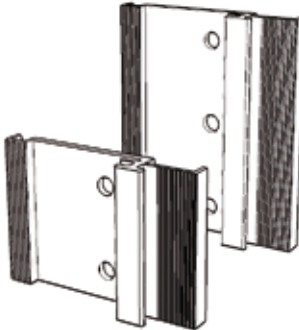
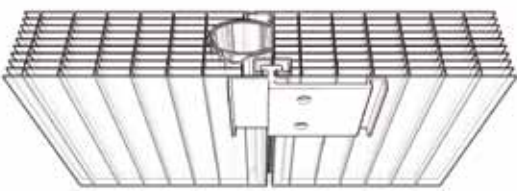

60

System	Clip fastener
PC 2560-12 AF 60	49405060
PC 2560-12 AF 120	494050120

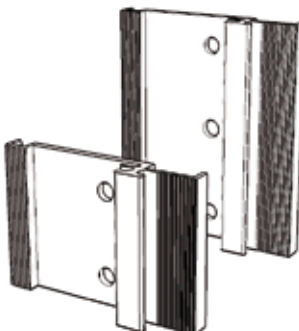
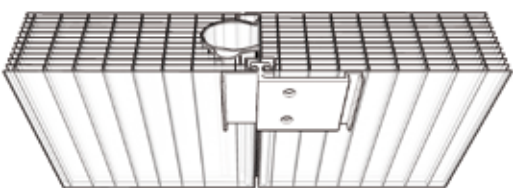

Fasteners

30

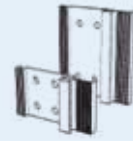

40



50



60

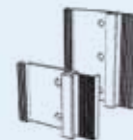

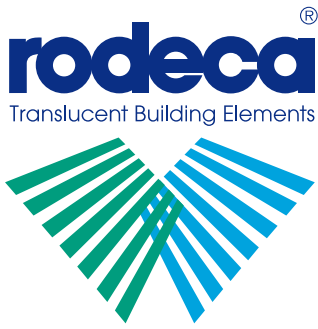

Translucent Building Elements

 Multi Wall Sheets
Hohkammerscheiben

 Multi Function Panels
Multi - Funktions-Paneele

 U-Panels
U-Paneele

Translucent Building Elements

Thermally broken aluminium frame profiles

The thermally broken perimeter frame profiles are made of extruded aluminium (type EN AW-6060, status T 66 according to DIN EN 755-2). The ribs are made of fibre glass reinforced polyamide PA 66 with fibre glass part of 25%. The gaskets are made of TPE.

Non-thermally broken aluminium frame profiles

The non-thermally broken perimeter frame profiles are made of extruded aluminium (type EN AW-6060, status T 66 according to DIN EN 755-2). The gaskets are made of TPE.

Framing systems

The perimeter frame profiles are available in thermally broken and non-thermally broken versions. They provide the main retention point of the panels to give a clean and water tight finish to the facade perimeter. Available in mill or anodized finish or powder coated to RAL.





RT-Thermolight
RT-Thermolight

RT-Roof Lights
RT-Dachlichtbänder

Windows
Fenster

Do it yourself
Do it yourself



An example for thermally broken frame profiles

Two pieces top and side profile with inner and outer gasket



Two pieces base profile with inner and outer gasket

Profiles



30

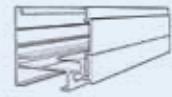

40

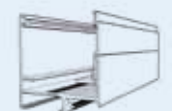
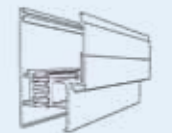
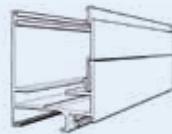

50

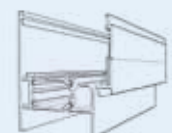
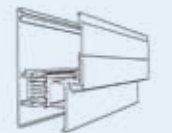

60

Application

Installation advice, application requirements and further technical information can be viewed in our technical manuals and installation manuals.



Germany

RODECA GmbH
Freiherr-vom-Stein-Straße 165
D-45473 Mülheim an der Ruhr
Fon +49 (0) 208 76502-0
Fax +49 (0) 208 76502-11
info@rodeca.de
www.rodeca.de

United Kingdom

RODECA Ltd.
Bentalls House
Bentalls
Pipps Hill Industrial Estate
Basildon
Essex SS14 3BS
Fon + 44 (0) 1268 531466
Fax + 44 (0) 1268 526351
sales@rodeca.co.uk
www.rodeca.co.uk

Italy

ANSA Termoplastici S.r.l./RODECA Italy
Concessionaria per l'Italia di RODECA GmbH
Via Nazionale, 66
24060 Sovere (BG)
Fon +39 035 981431
Fax +39 035 982714
info@rodeca.it
www.rodeca.it

The Netherlands

RODECA Systems b.v.
Koperweg 11 N
2401 LH Alphen aan den Rijn
Fon +31 (0) 172 416 747
Fax +31 (0) 172 419 090
info@rodeca.nl
www.rodeca.nl

Belgium and Luxembourg

RODECA Systems BELUX bvba
Wupstraat 37
2812 Muizen/Mechelen
Mobile +32 (0) 468 137 677
Fax (NL) +31 (0) 172 419 090 (RODECA Systems b.v.)
info@rodeca.be
www.rodeca.be

South America

REPLAEX RESINAS PLÁSTICAS EXTRUDADAS LTDA
Autorizado America do Sul de RODECA GmbH
Estrada da Ligação, 839 - Taquara - Rio de Janeiro
RJ - BRASIL
cep. 22713-470
Fon : +55 (0) 21 2446-8811
Fax : +55 (0) 21 2446-7181
info@rodeca.com.br
www.rodeca.com.br
www.replaex.com.br

The RODECA product groups overview / Die RODECA Produktgruppen im Überblick:

 **Translucent Building Elements**
Lichtbauelemente

 **Multi Wall Sheets**
Hohlkammerscheiben

 **Multi Function Panels**
Multi-Funktions-Paneele

 **U-Panels**
U-Paneele

 **RT-Thermolight**
RT-Thermolight

 **RT-Roof Lights**
RT-Dachlichtbänder

 **Windows**
Fenster

 **Do it yourself**
Do it yourself