

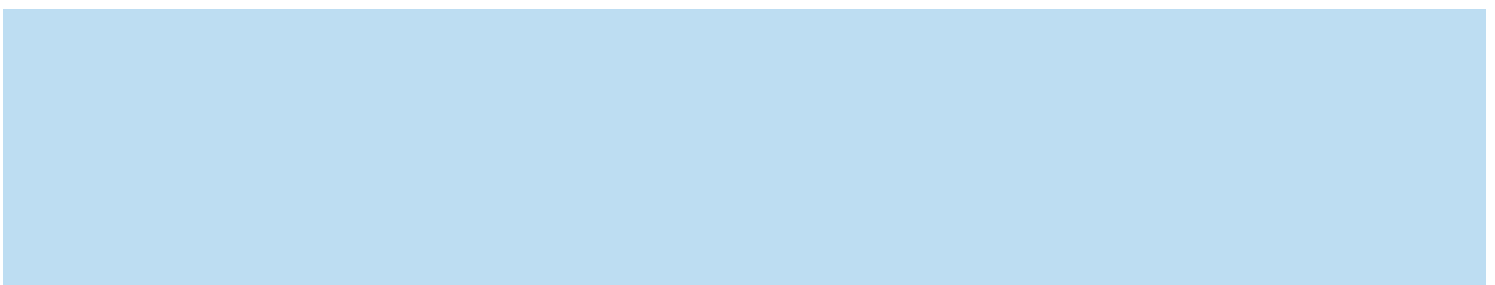

RT-Thermolight

RT-Thermolight



RT-Thermolight

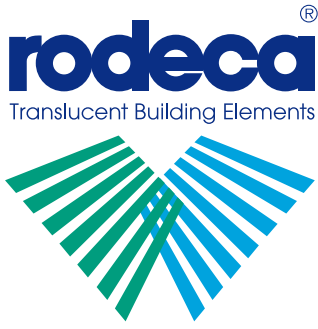

RT-Thermolight



Multi Wall Sheets
Hohkammerscheiben



RT-Roof Lights
RT-Dachlichtbänder



U-Panels
U-Paneele



RT-Thermolight

Advantages

- quick and easy installation
- translucent
- heat-insulating
- high temperature resistance
- versatile designing in shape, colour and function
- good long term performance through UV protection
- 200 times tougher than glass
- shatter proof

Applications

- Roofings
- Sports and industrial buildings
- Roof constructions
- Roof lights - flat and curved
- Non airconditioned spaces
- Roof lights integrated into corrugated sheet roofing constructions
- Refurbishment

General information RT-Thermolight

The RT-Thermolight offers three polycarbonate panels that can be incorporated into a flat, trapezoidal or corrugated roofing construction to various widths. Offering high insulation values and light transmission these light weight systems are extremely weather and impact resistant.

With minimal use of alloy components all systems are quick, easy and economical to install.

List of content

Overview RT-Thermolight	page 2
PC 2685-3	page 3
PC 29330-XL	page 4
Thermolight 1000	page 5



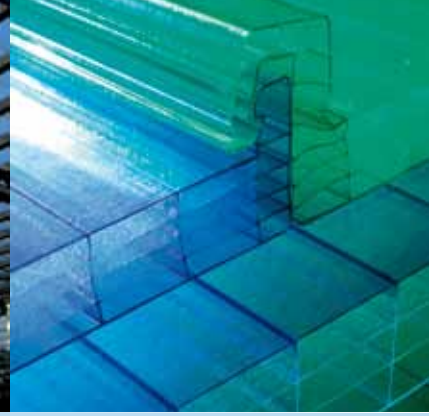

Multi Function Panels
Multi-Funktion-Paneele







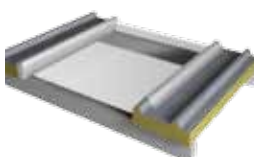

Translucent Building Elements
Lichtbauelemente

Windows
Fenster

Do it yourself
Do it yourself

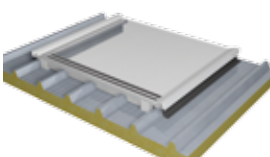
Systems overview RT-Thermolight

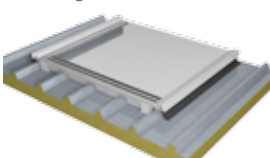
The following table shows an overview of the RT-Thermolight systems from Rodeca. The specified span widths relate to a load pressure of 1.00 kN/m². Please inquire for project specific load information.

<p>PC 29330-XL</p> 	<p>pitched system > 5°</p> 	<p>span width 1.30m*</p>
<p>PC 2685-3</p> 	<p>pitched system > 5°</p> 	<p>span width 1.50m*</p>
<p>Thermolight 1000</p> 	<p>pitched system > 5°</p> 	<p>span width 3.00m*</p>
<p>Thermolight 1000</p> 	<p>curved application R>10.00m</p> 	<p>span width 3.00m*</p>

* Recommended span width for load pressure of 1.00kN/m² and 15° pitch.

Panels Thermolight



PC 29330-XL

Colours
clear / opal from 3t

Thickness (mm)	30
Building width (mm)	930 (+1/-1%)
Weight (kg/Lfm)	approx. 3.6



PC 2685-3

Colours
Standard: crystal Color version from 400 m²

Thickness (mm)	40/85
Building width (mm)	600 (+1/-1%)
Weight (kg/m ²)	approx. 5.20



Thermolight 1000

Colours
Standard: clear Color Version from 400 m²
Decocolor Heatbloc from 400m²

Thickness (mm)	20
Building width (mm)	1080 (+1/-1%)
Weight (kg/m ²)	approx. 2.9

All installation advice, application requirements and further technical information can be viewed in our technical product data sheets and installation manuals.

RODECA GmbH
Freiherr-vom-Stein-Straße 165
D-45473 Mülheim an der Ruhr
Fon +49 (0) 208 76502-0 | Fax +49 (0) 208 76502-11
info@rodeca.de | www.rodeca.de

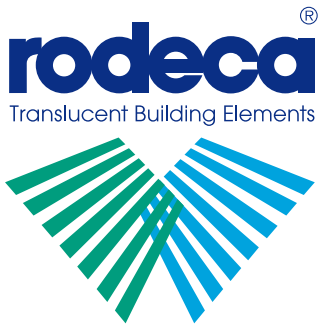

RT-Thermolight



Multi Wall Sheets
Hohkammerscheiben



RT-Roof Lights
RT-Dachlichtbänder



U-Panels
U-Paneele



RT-Thermolight

Accessories

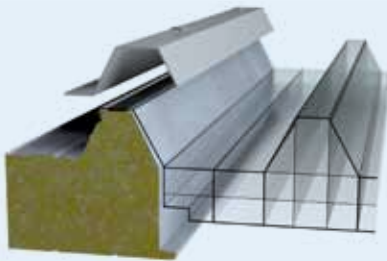

Recommended fixing
End plates (provided from installer) on top of the high corrugation and polycarbonate panel

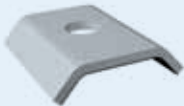

Alternate fixing
Retention washer
Item no.: 494002



Sealing band 30*5
Item no.: 9019020005



2685-3

Thickness (mm)	40/85
Building width (mm)	600 (+1/-1%)
Weight (kg/m ²)	approx. 5.2

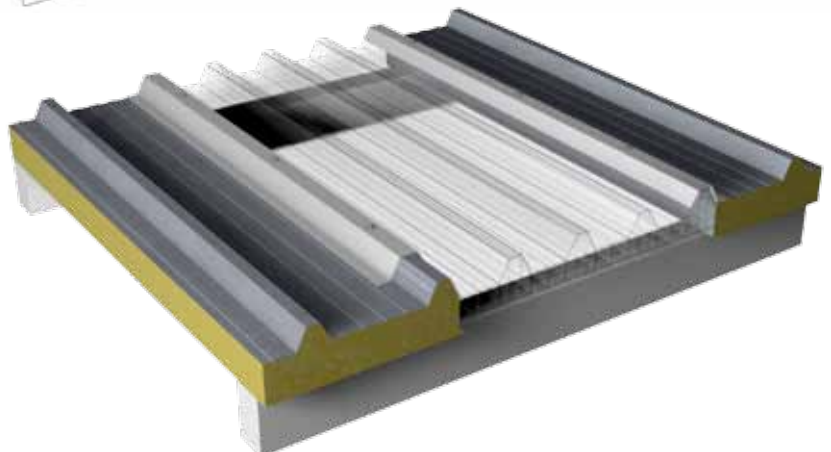
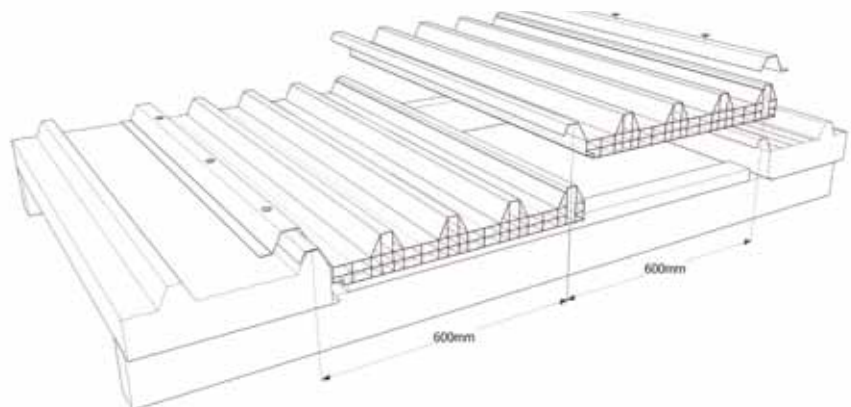
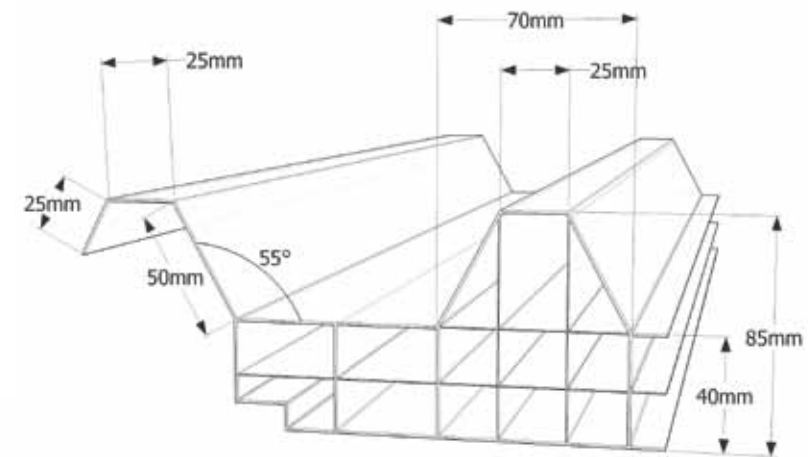

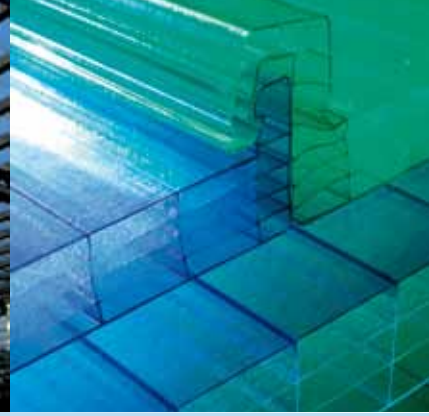

 Multi Function Panels
Multi-Funktion-Paneele

 Translucent Building Elements
Lichtbauelemente

 Windows
Fenster

 Do it yourself
Do it yourself

Thermolight 1000

The RT-Thermolight comprises a 20mm thick Polycarbonate Multi Wall Sheet with side integrated corrugations placed onto custom-fitted aluminium profiles. The cover width of 1000mm makes it the ideal solution for non-airconditioned spaces with usual sandwich panel roofing. Integrated ventilation windows can be installed with a recommended minimum pitch of 10°.

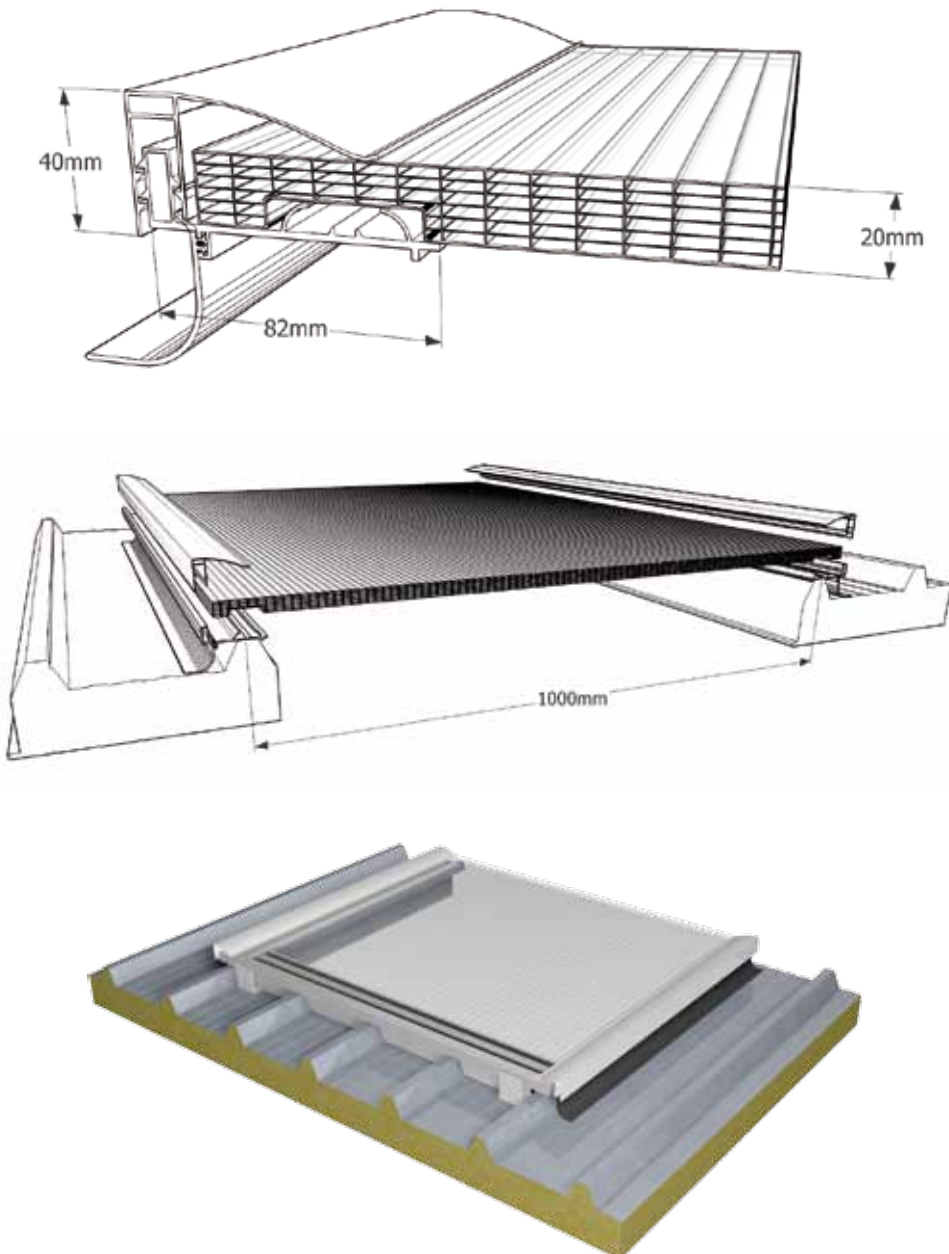

Accessories

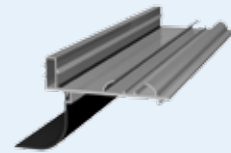

Base profile
Item no.: 46208060
with gasket
Item no.: 902107 EPDM black

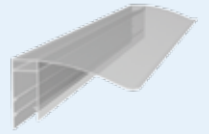

PC Cover profile
Item no.: 881111



Drip profile
Item no.: 462011



Sealing band 30*5
Item no.: 9019020005

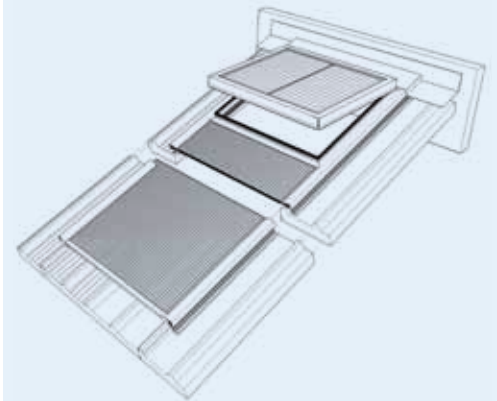

Integrated roof window



RT-Thermolight 1000

Thickness (mm)	20
Building width (mm)	1080 (+1/-1%)
Weight (kg/m ²)	approx. 2.9

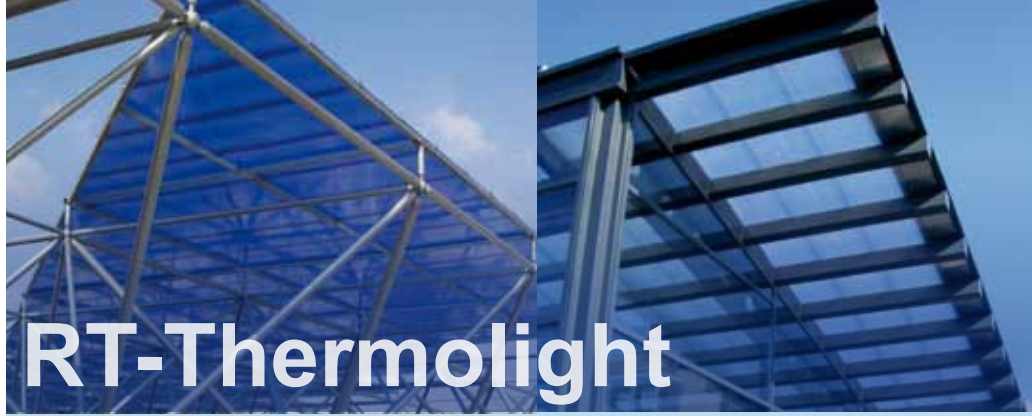
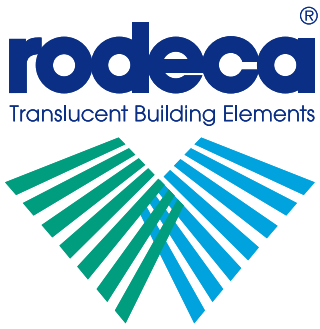

RT-Thermolight

Multi Wall Sheets
Hohkammerscheiben

RT-Roof Lights
RT-Dachlichtbänder

U-Panels
U-Paneele

RT-Thermolight

Accessories

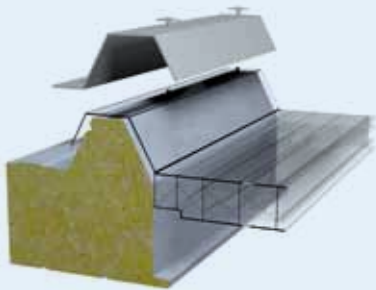

Recommended fixing
End plates (provided from installer)
on top of the high corrugation and polycarbonate panel

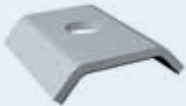

Alternate fixing
Retention washer
Item no.: 494002



Sealing band 30*5
Item no.: 9019020005



PC 29330-XL

Thickness (mm)	30
Building width (mm)	930 (+1/-1%)
Weight (kg/Lfm)	approx. 3.60

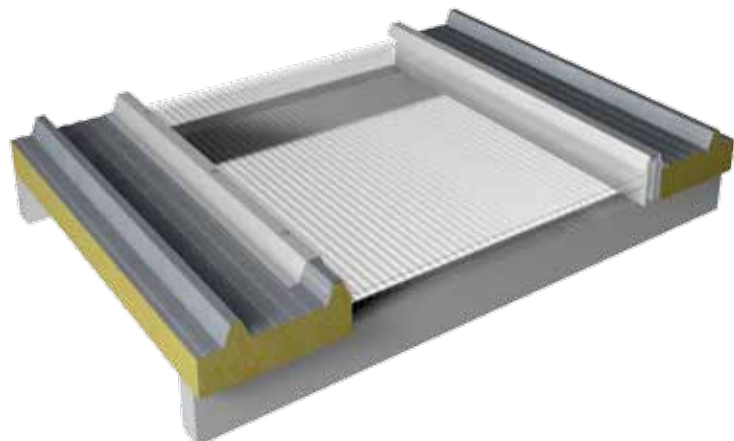
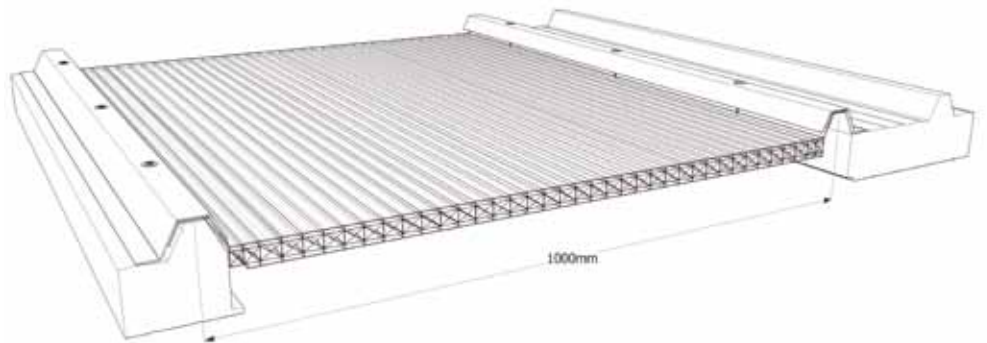
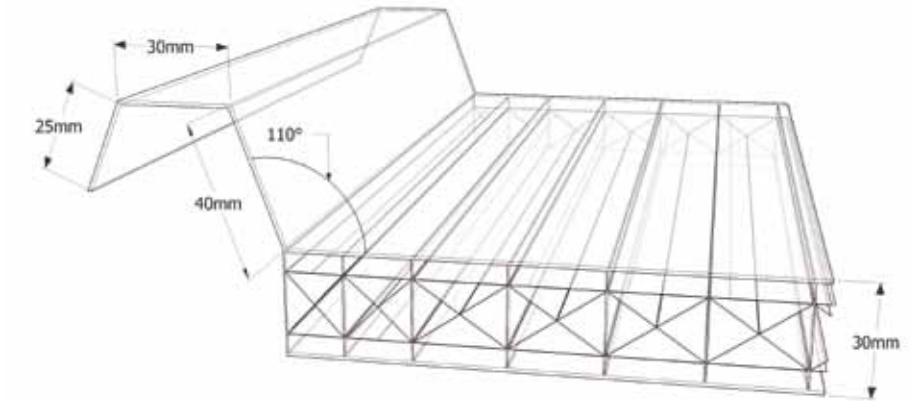

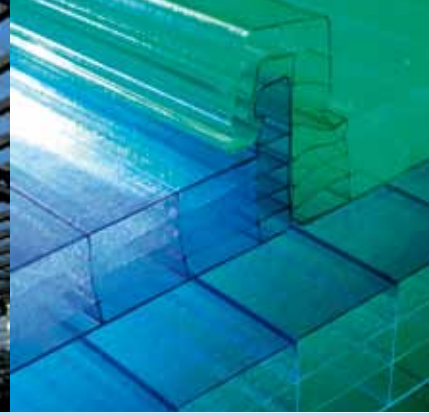

Multi Function Panels
Multi-Funktion-Paneele

Translucent Building Elements
Lichtbauelemente

Windows
Fenster

Do it yourself
Do it yourself

Customisation of side lap features

The added value of PC 29330-XL is the possibility to change dimensions of side lap features with relatively small investments (depending on ordered quantity). This way a wide variety of shapes and sizes is possible and depending on customer requirements the high corrugation can be adapted to shape of composite panel intended for use.

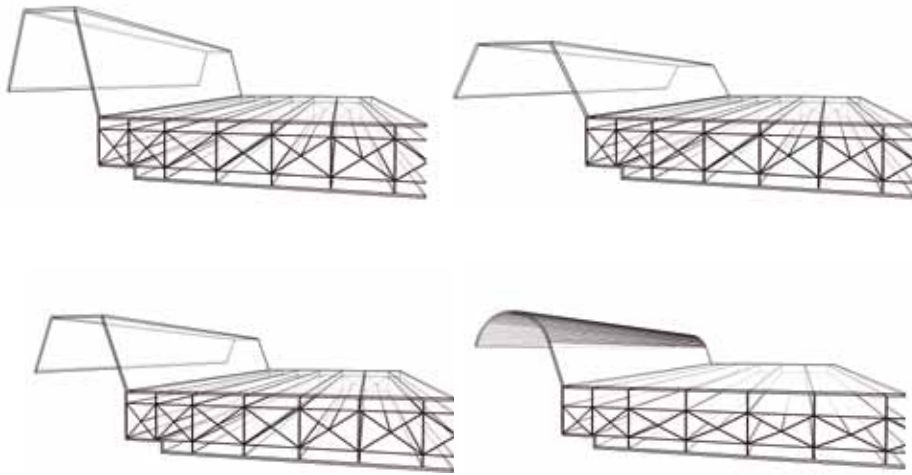

Overlapping of PC 29330-XL lengthwise

Due to the possibility to overlap the panels, nearly every length in roofings can be realised. A hollow section will be placed onto high corrugation and the next panel is placed onto it. The sealing must be provided from installer. Minimum overlapping shall be 300mm. For modelling of all necessary end plates provided from installer, please inquire the exact panel dimensions in advance.

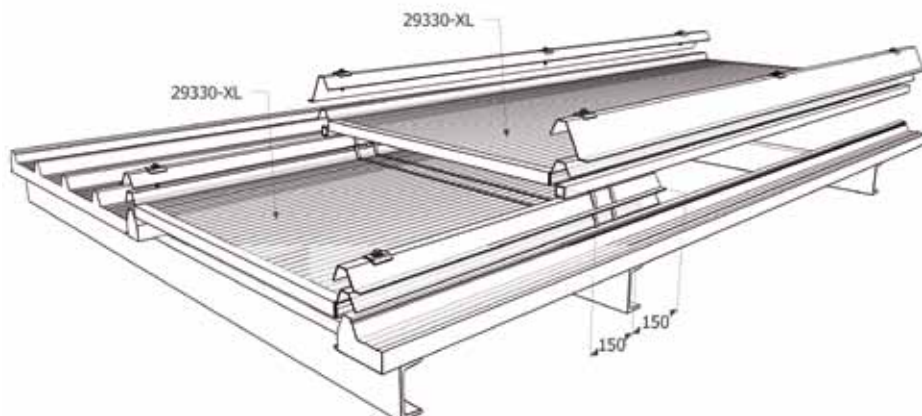

Accessories

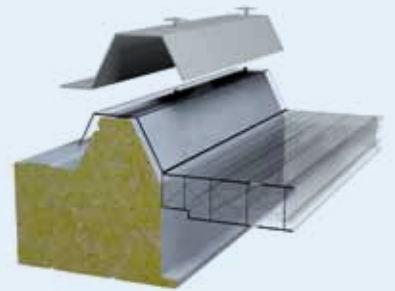

Recommended fixing
End plates (provided from installer) on top of the high corrugation and polycarbonate panel

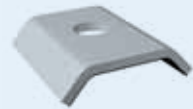

Alternate fixing
Retention washer
Item no.: 494002



Sealing band 30*5
Item no.: 9019020005

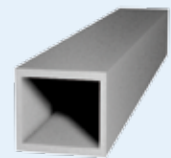

Squared hollow section 30*30 (provided from installer)

RODECA GmbH
Freiherr-vom-Stein-Straße 165
D-45473 Mülheim an der Ruhr
Fon +49 (0) 208 76502-0 | Fax +49 (0) 208 76502-11
info@rodeca.de | www.rodeca.de



Germany

RODECA GmbH
Freiherr-vom-Stein-Straße 165
D-45473 Mülheim an der Ruhr
Fon +49 (0) 208 76502-0
Fax +49 (0) 208 76502-11
info@rodeca.de
www.rodeca.de

United Kingdom

RODECA Ltd.
Bentalls House
Bentalls
Pipps Hill Industrial Estate
Basildon
Essex SS14 3BS
Fon + 44 (0) 1268 531466
Fax + 44 (0) 1268 526351
sales@rodeca.co.uk
www.rodeca.co.uk

Italy

ANSA Termoplastici S.r.l./RODECA Italy
Concessionaria per l'Italia di RODECA GmbH
Via Nazionale, 66
24060 Sovere (BG)
Fon +39 035 981431
Fax +39 035 982714
info@rodeca.it
www.rodeca.it

The Netherlands

RODECA Systems b.v.
Koperweg 11 N
2401 LH Alphen aan den Rijn
Fon +31 (0) 172 416 747
Fax +31 (0) 172 419 090
info@rodeca.nl
www.rodeca.nl

Belgium and Luxembourg

RODECA Systems BELUX bvba
Wupstraat 37
2812 Muizen/Mechelen
Mobile +32 (0) 468 137 677
Fax (NL) +31 (0) 172 419 090 (RODECA Systems b.v.)
info@rodeca.be
www.rodeca.be

South America

REPLAEX RESINAS PLÁSTICAS EXTRUDADAS LTDA
Autorizado America do Sul de RODECA GmbH
Estrada da Ligação, 839 - Taquara - Rio de Janeiro
RJ - BRASIL
cep. 22713-470
Fon : +55 (0) 21 2446-8811
Fax : +55 (0) 21 2446-7181
info@rodeca.com.br
www.rodeca.com.br
www.replaex.com.br

The RODECA product groups overview / Die RODECA Produktgruppen im Überblick:

 **Translucent Building Elements**
Lichtbauelemente

 **Multi Wall Sheets**
Hohlkammerscheiben

 **Multi Function Panels**
Multi-Funktions-Paneele

 **U-Panels**
U-Paneele

 **RT-Thermolight**
RT-Thermolight

 **RT-Roof Lights**
RT-Dachlichtbänder

 **Windows**
Fenster

 **Do it yourself**
Do it yourself